

precision voltage reference

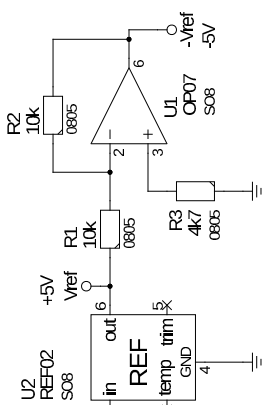

CONN3  
PS-256G BR  
PS\_8PIN

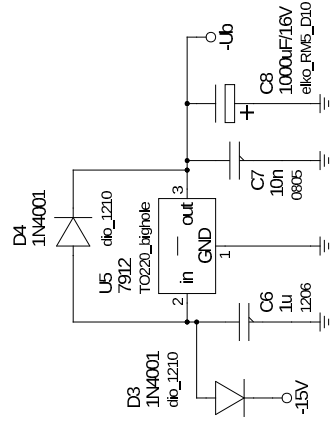
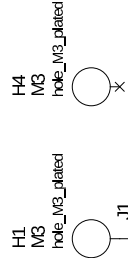
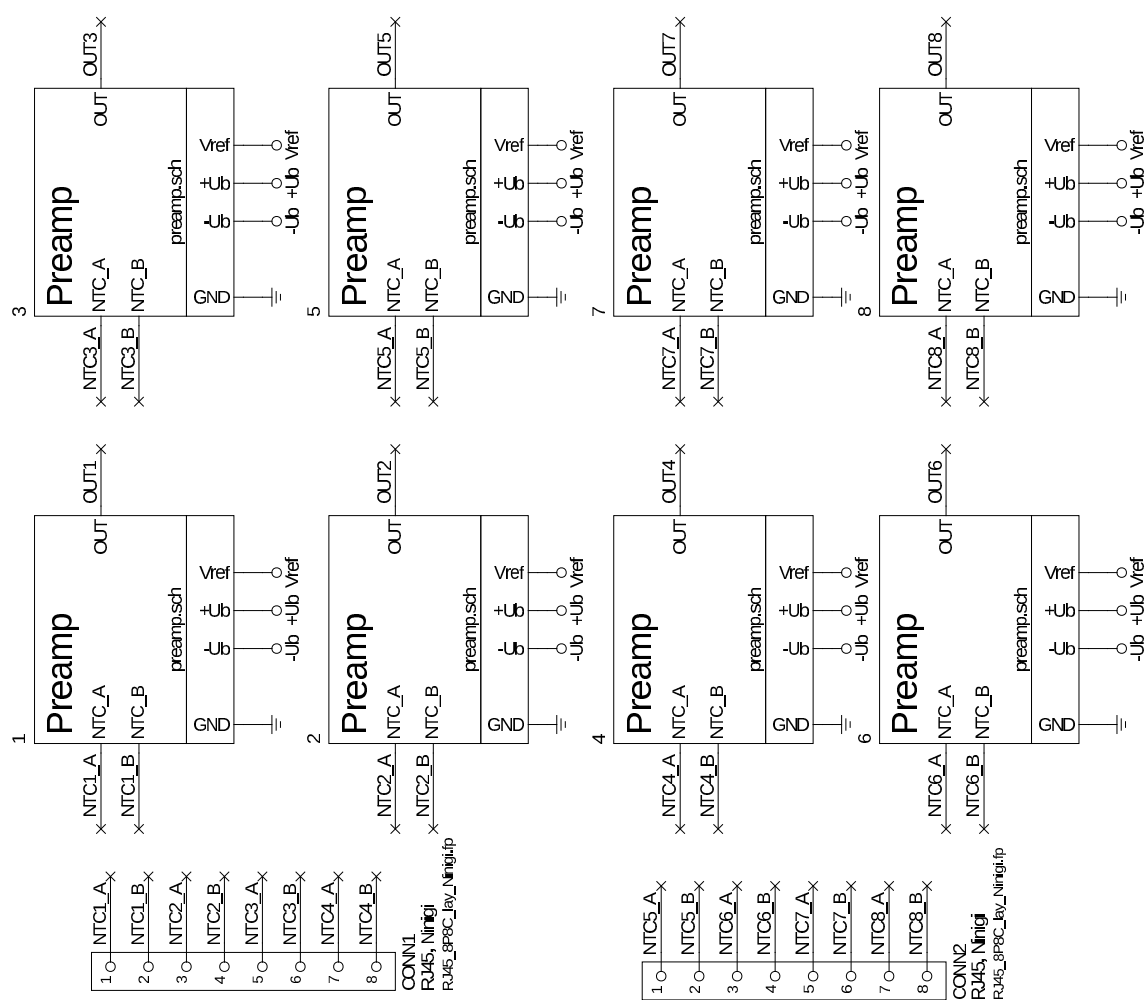
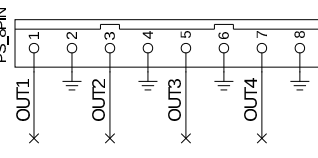

CONN4  
PS-256G BR  
PS\_8PIN

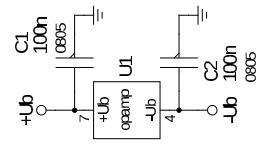
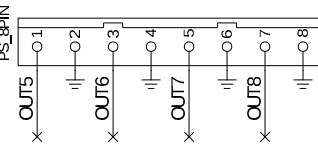

TITLE:	Therm8
PROJECT:	Therm8
FILE:	thermo8.sch

M1  
Hammond 1590QBK  
BOX\_HAMMOND\_1590Q

REV.:	1.0
DATE:	01.04.15
PAGE:	1 / 2

DRWBY: dholzward

Opamp power supply

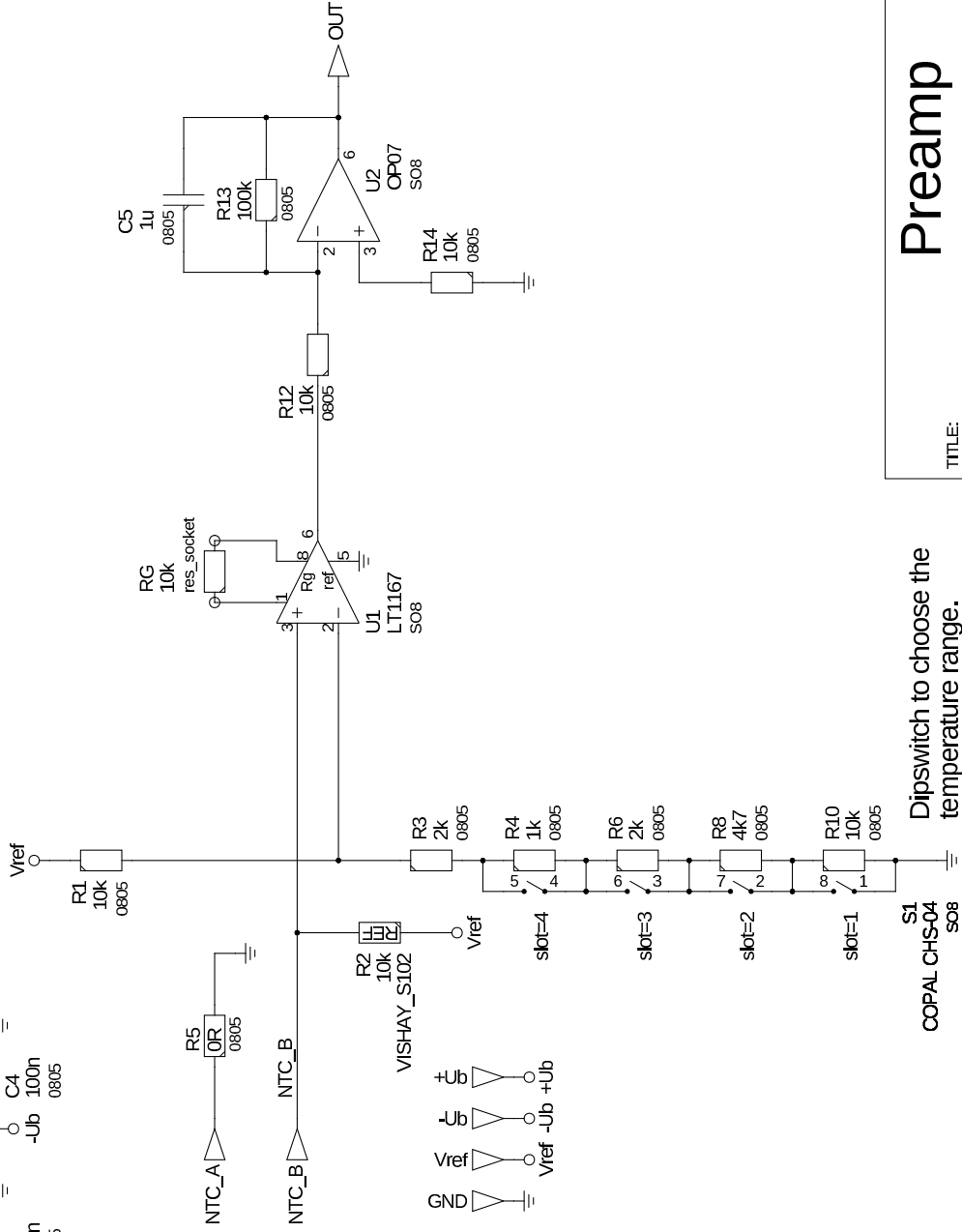
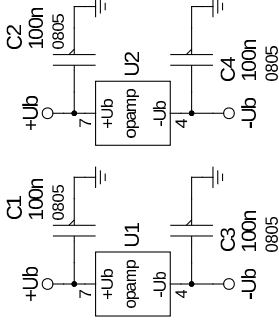

Dipswitch to choose the temperature range.

<b>Preamp</b>		REV.: 1.0
PROJECT: Thermo8		DATE: 01.04.15
FILE: preamp.sch	DRAWN BY: dholzward	
TITLE:		PAGE: 2 / 2