

precision voltage reference

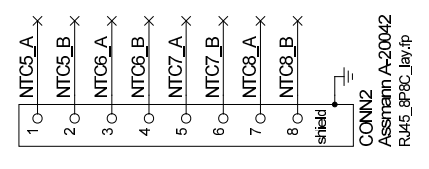

TITLE: Thermo8		REV.: 1.0
		PROJECT: thermo8.sch
DRAWN BY: dholzward		DATE: 01.04.15
FILE: thermo8.sch		PAGE: 1 / 2

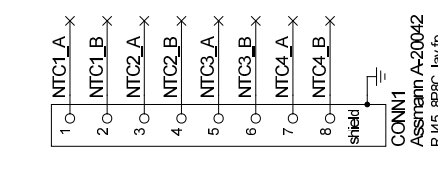
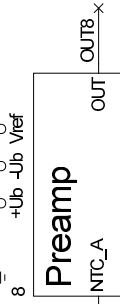
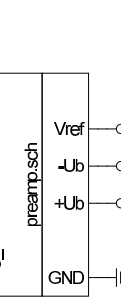
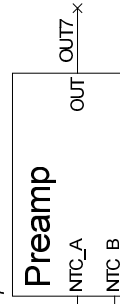
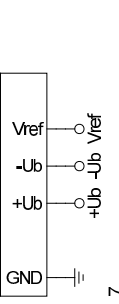
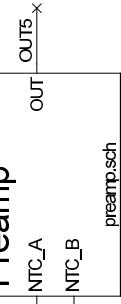
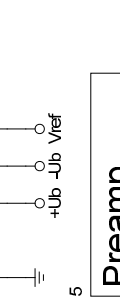
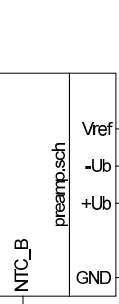
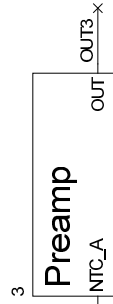
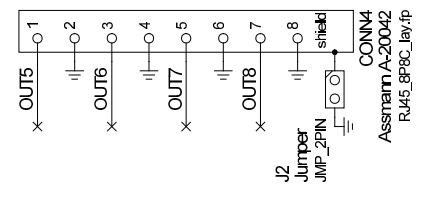
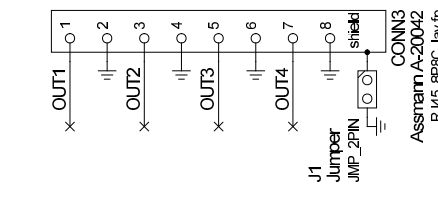
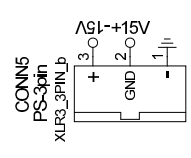
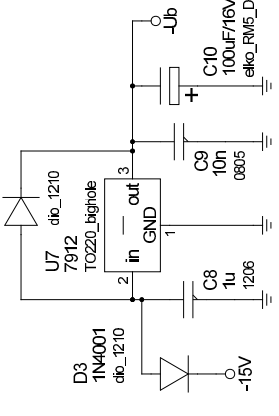
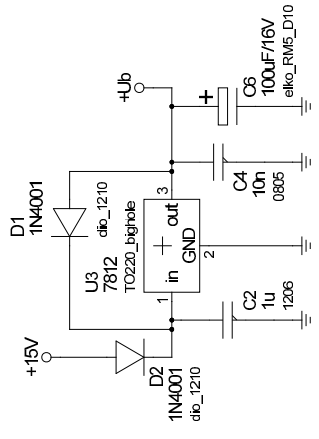
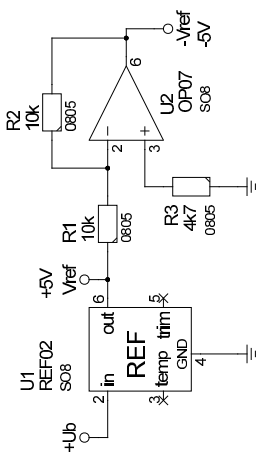

Opamp power supply

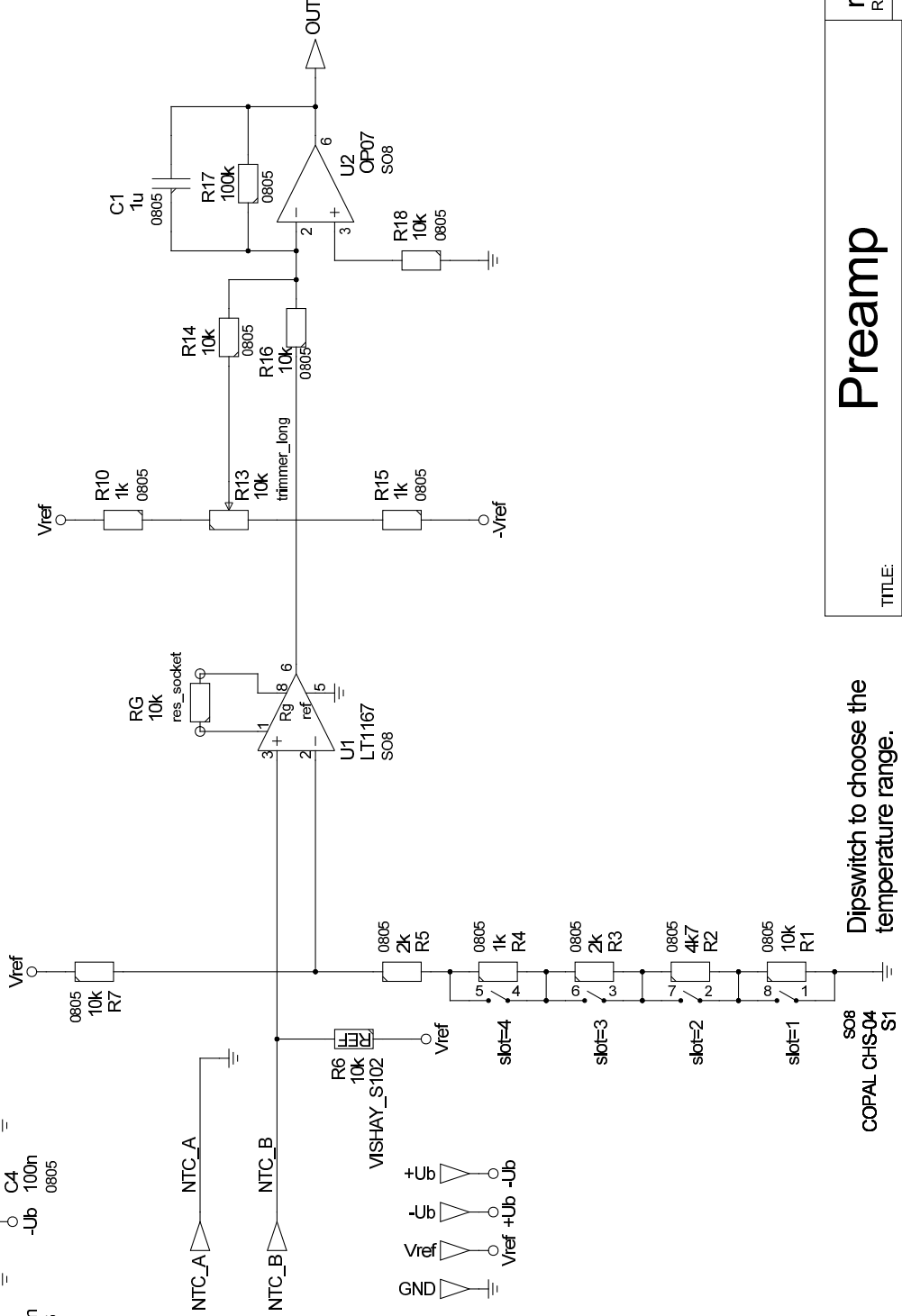
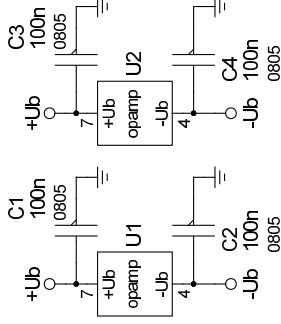

revision	
REV.:	DD.MM.YY
DATE:	
PAGE: n / m	
author	
PROJECT:	thermo8
FILE:	preamp.sch
DRAWN BY:	

Dipswitch to choose the temperature range.

S08
COPAL CHS-04
S1