

LCD-Display

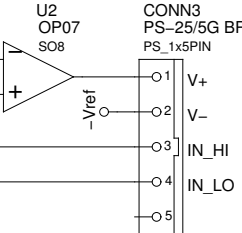

Peltier Current

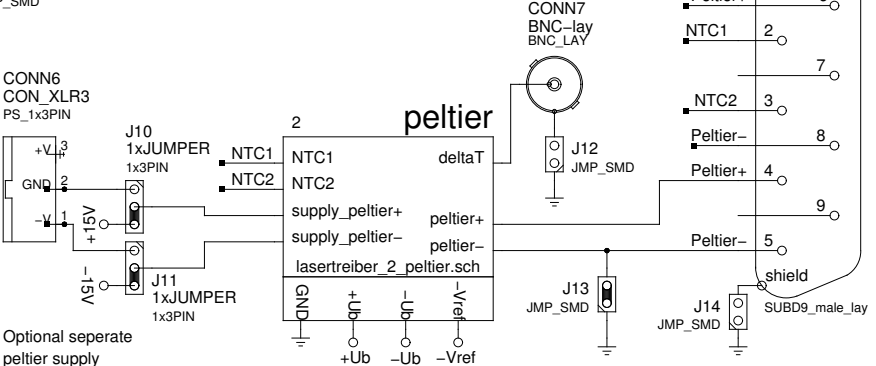

Diode Current

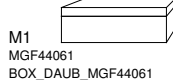
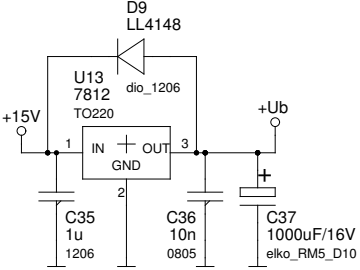
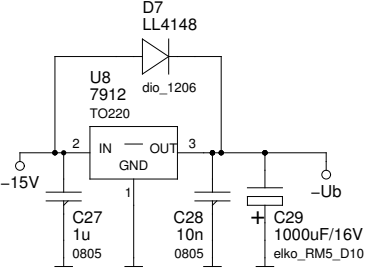
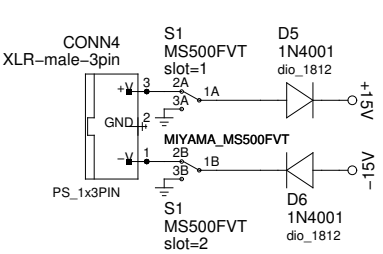
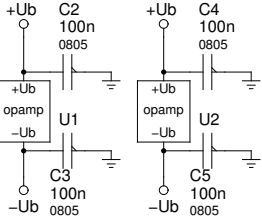

BNC-LAY = Telegaertner J01001A0037

<h2 style="text-align: center;">Lasertreiber (master)</h2>		2.0
		REV.:
TITLE		01.09.08
FILE: lasertreiber_0_master.sch		DATE:
DRAWN BY: <(kmk)>		PAGE: 1/4