

Small Signal Diode

1N91x, 1N4x48, FDLL914, FDLL4x48

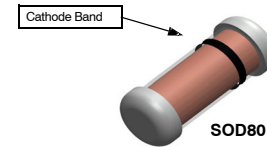

DO-35
Cathode is denoted with a black band



LL-34
THE PLACEMENT OF THE EXPANSION GAP HAS NO RELATIONSHIP TO THE LOCATION OF THE CATHODE TERMINAL

ORDERING INFORMATION

| Part Number | Marking | Package | Packing Method |
|---------------|---------|------------------|----------------|
| 1N914 | 914 | DO-204AH (DO-35) | Bulk |
| 1N914-T50A | 914 | DO-204AH (DO-35) | Ammo |
| 1N914TR | 914 | DO-204AH (DO-35) | Tape and Reel |
| 1N914ATR | 914A | DO-204AH (DO-35) | Tape and Reel |
| 1N914B | 914B | DO-204AH (DO-35) | Bulk |
| 1N914BTR | 914B | DO-204AH (DO-35) | Tape and Reel |
| 1N916 | 916 | DO-204AH (DO-35) | Bulk |
| 1N916A | 916A | DO-204AH (DO-35) | Bulk |
| 1N916B | 916B | DO-204AH (DO-35) | Bulk |
| 1N4148 | 4148 | DO-204AH (DO-35) | Bulk |
| 1N4148TA | 4148 | DO-204AH (DO-35) | Ammo |
| 1N4148-T26A | 4148 | DO-204AH (DO-35) | Ammo |
| 1N4148-T50A | 4148 | DO-204AH (DO-35) | Ammo |
| 1N4148TR | 4148 | DO-204AH (DO-35) | Tape and Reel |
| 1N4148-T50R | 4148 | DO-204AH (DO-35) | Tape and Reel |
| 1N4448 | 4448 | DO-204AH (DO-35) | Bulk |
| 1N4448TR | 4448 | DO-204AH (DO-35) | Tape and Reel |
| FDLL914 | Black | SOD-80 | Tape and Reel |
| FDLL914A | Black | SOD-80 | Tape and Reel |
| FDLL914B | Black | SOD-80 | Tape and Reel |
| FDLL4148 | Black | SOD-80 | Tape and Reel |
| FDLL4148-D87Z | Black | SOD-80 | Tape and Reel |
| FDLL4448 | Black | SOD-80 | Tape and Reel |
| FDLL4448-D87Z | Black | SOD-80 | Tape and Reel |

SOD-80 COLOR BAND MARKING

| DEVICE | 1ST BAND |
|----------|----------|
| FDLL914 | BLACK |
| FDLL914A | BLACK |
| FDLL914B | BLACK |
| FDLL4148 | BLACK |
| FDLL4448 | BLACK |

-1st band denotes cathode terminal and has wider width

1N91x, 1N4x48, FDLL914, FDLL4x48

ABSOLUTE MAXIMUM RATINGS (Values are at $T_A = 25^\circ\text{C}$ unless otherwise noted) (Note 1)

| Rating | Symbol | Value | Unit | |
|---|-----------|---------------------------------|------------------|---|
| Maximum Repetitive Reverse Voltage | V_{RRM} | 100 | V | |
| Average Rectified Forward Current | I_O | 200 | mA | |
| DC Forward Current | I_F | 300 | mA | |
| Recurrent Peak Forward Current | I_f | 400 | mA | |
| Non-repetitive Peak Forward Surge Current | | Pulse Width = 1.0 s | 1.0 | A |
| | | Pulse Width = 1.0 μs | 4.0 | A |
| Storage Temperature Range | T_{STG} | -65 to +200 | $^\circ\text{C}$ | |
| Operating Junction Temperature Range | T_J | -55 to +175 | $^\circ\text{C}$ | |

Stresses exceeding those listed in the Maximum Ratings table may damage the device. If any of these limits are exceeded, device functionality should not be assumed, damage may occur and reliability may be affected.

1. These ratings are limiting values above which the serviceability of the diode may be impaired.

THERMAL CHARACTERISTICS

| Parameter | Symbol | Max | Unit |
|---|-----------------|-----|------------------|
| Power Dissipation | P_D | 500 | mW |
| Thermal Resistance, Junction-to-Ambient | $R_{\theta JA}$ | 300 | $^\circ\text{C}$ |

ELECTRICAL CHARACTERISTICS (Values are at $T_A = 25^\circ\text{C}$ unless otherwise noted) (Note 2)

| Symbol | Parameter | Conditions | Min | Max | Unit | |
|----------|-----------------------|--|--------------------------------|-------|---------------|----|
| V_R | Breakdown Voltage | $I_R = 100 \mu\text{A}$ | 100 | | V | |
| | | $I_R = 5.0 \mu\text{A}$ | 75 | | V | |
| V_F | Forward Voltage | 914B / 4448 | $I_F = 5.0 \text{ mA}$ | 0.62 | 0.72 | V |
| | | 916B | $I_F = 5.0 \text{ mA}$ | 0.63 | 0.73 | V |
| | | 914 / 916 / 4148 | $I_F = 10 \text{ mA}$ | | 1.0 | V |
| | | 914A / 916A | $I_F = 20 \text{ mA}$ | | 1.0 | V |
| | | 916B | $I_F = 20 \text{ mA}$ | | 1.0 | V |
| | | 914B / 4448 | $I_F = 100 \text{ mA}$ | | 1.0 | V |
| I_R | Reverse Leakage | $V_R = 20 \text{ V}$ | | 0.025 | μA | |
| | | $V_R = 20 \text{ V}, T_A = 150^\circ\text{C}$ | | 50 | μA | |
| | | $V_R = 75 \text{ V}$ | | 5.0 | μA | |
| C_T | Total Capacitance | 916/916A/916B/4448 | $V_R = 0, f = 1.0 \text{ MHz}$ | | 2.0 | pF |
| | | 914/914A/914B/4148 | $V_R = 0, f = 1.0 \text{ MHz}$ | | 4.0 | pF |
| t_{rr} | Reverse Recovery Time | $I_F = 10 \text{ mA}, V_R = 6.0 \text{ V} (600 \text{ mA})$ $I_{rr} = 1.0 \text{ mA}, R_L = 100 \Omega$ | | 4.0 | ns | |

Product parametric performance is indicated in the Electrical Characteristics for the listed test conditions, unless otherwise noted. Product performance may not be indicated by the Electrical Characteristics if operated under different conditions.

2. Non-recurrent square wave $P_W = 8.3 \text{ ms}$.

1N91x, 1N4x48, FDLL914, FDLL4x48

TYPICAL PERFORMANCE CHARACTERISTICS



Figure 1. Reverse Voltage vs. Reverse Current
 $B_V - 1.0$ to $100 \mu A$

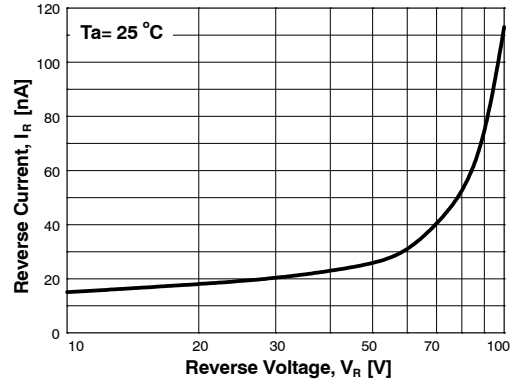

Figure 2. Reverse Current vs. Reverse Voltage
 $I_R - 10$ to $100 V$

GENERAL RULE: The Reverse Current of a diode will approximately double for every ten (10) Degree C increase in Temperature



Figure 3. Forward Voltage vs. Forward Current
 $V_F - 1$ to $100 \mu A$



Figure 4. Forward Voltage vs. Forward Current
 $V_F - 0.1$ to $10 mA$



Figure 5. Forward Voltage vs. Forward Current
 $V_F - 10$ to $800 mA$

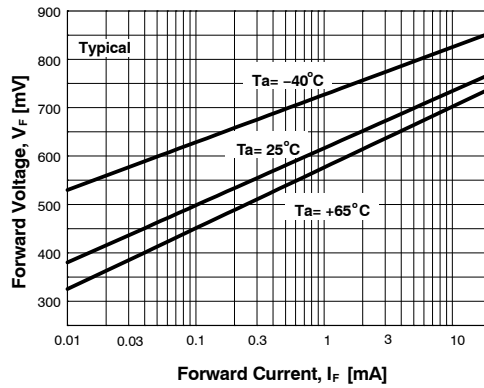

Figure 6. Forward Voltage vs. Ambient Temperature
 $V_F - 0.01 - 20 mA (-40$ to $+65^\circ C)$

1N91x, 1N4x48, FDLL914, FDLL4x48

TYPICAL PERFORMANCE CHARACTERISTICS



Figure 7. Total Capacitance

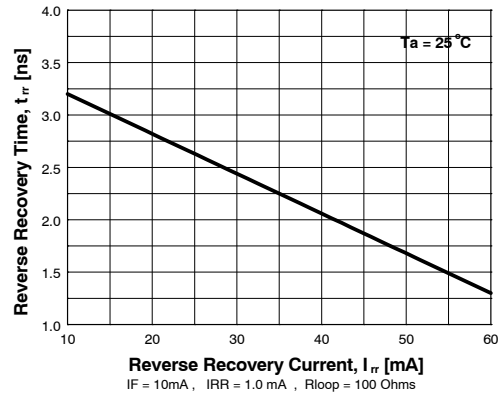

Figure 8. Reverse Recovery Time vs. Reverse Recovery Current

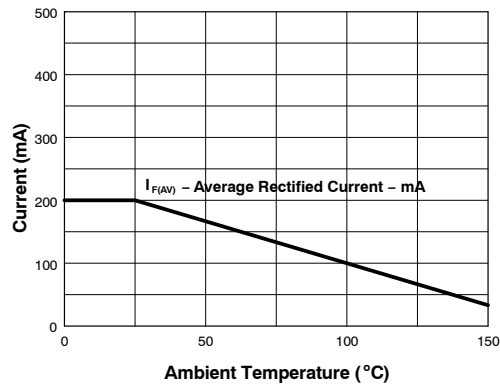

Figure 9. Average Rectified Current ($I_{F(AV)}$) vs. Ambient Temperature (T_A)

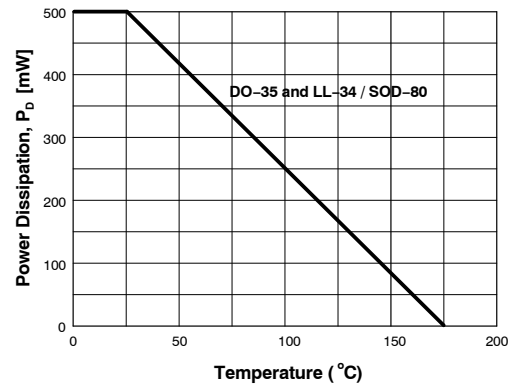

Figure 10. Power Derating Curve

AXIAL LEAD
CASE 017AG
ISSUE 0

DATE 31 AUG 2016



- NOTES: UNLESS OTHERWISE SPECIFIED
- A) PACKAGE STANDARD REFERENCE: JEDEC DO-204, VARIATION AH.
 - B) HERMETICALLY SEALED GLASS PACKAGE.
 - C) PACKAGE WEIGHT IS 0.137 GRAM.
 - D) ALL DIMENSIONS ARE IN MILLIMETERS.

| | | |
|-------------------------|--------------------|--|
| DOCUMENT NUMBER: | 98AON13443G | Electronic versions are uncontrolled except when accessed directly from the Document Repository. Printed versions are uncontrolled except when stamped "CONTROLLED COPY" in red. |
| DESCRIPTION: | AXIAL LEAD | PAGE 1 OF 1 |

ON Semiconductor and  are trademarks of Semiconductor Components Industries, LLC dba ON Semiconductor or its subsidiaries in the United States and/or other countries. ON Semiconductor reserves the right to make changes without further notice to any products herein. ON Semiconductor makes no warranty, representation or guarantee regarding the suitability of its products for any particular purpose, nor does ON Semiconductor assume any liability arising out of the application or use of any product or circuit, and specifically disclaims any and all liability, including without limitation special, consequential or incidental damages. ON Semiconductor does not convey any license under its patent rights nor the rights of others.

MECHANICAL CASE OUTLINE
PACKAGE DIMENSIONS



MiniMELF / SOD-80
CASE 100AD
ISSUE O

DATE 30 APR 2012

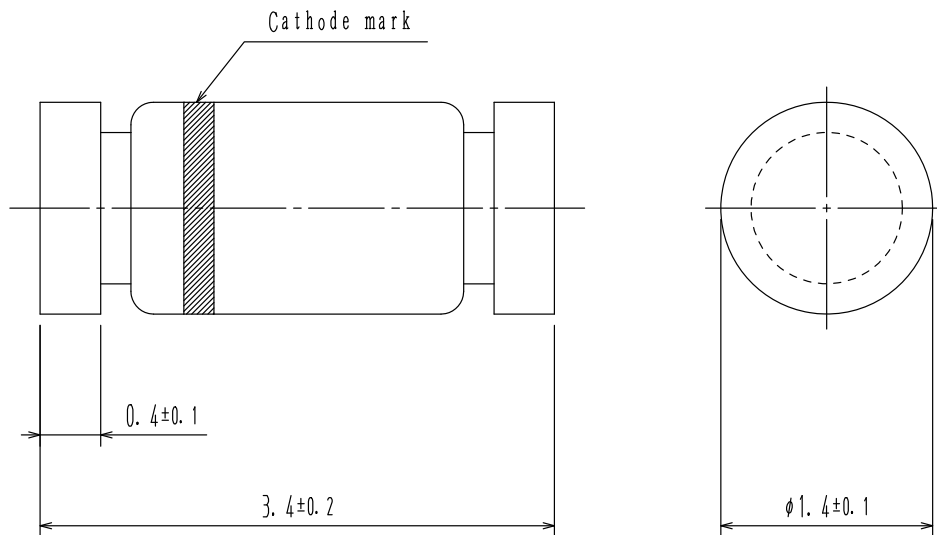

NOTES: UNLESS OTHERWISE SPECIFIED

- A) PACKAGE STANDARD REFERENCE:
JEDEC DO-213, VARIATION AC.
- B) ALL DIMENSIONS ARE IN MILLIMETERS.
- C)  CORNER RADIUS IS OPTIONAL.
- D) DRAWING FILE NAME: SOD80A REV01

| | | |
|-------------------------|--------------------------|---|
| DOCUMENT NUMBER: | 98AON79582E | Electronic versions are uncontrolled except when accessed directly from the Document Repository. Printed versions are uncontrolled except when stamped "CONTROLLED COPY" in red. |
| DESCRIPTION: | MINIMELF / SOD-80 | PAGE 1 OF 1 |

onsemi and **ONSEMI** are trademarks of Semiconductor Components Industries, LLC dba **onsemi** or its subsidiaries in the United States and/or other countries. **onsemi** reserves the right to make changes without further notice to any products herein. **onsemi** makes no warranty, representation or guarantee regarding the suitability of its products for any particular purpose, nor does **onsemi** assume any liability arising out of the application or use of any product or circuit, and specifically disclaims any and all liability, including without limitation special, consequential or incidental damages. **onsemi** does not convey any license under its patent rights nor the rights of others.

onsemi, **Onsemi**, and other names, marks, and brands are registered and/or common law trademarks of Semiconductor Components Industries, LLC dba "**onsemi**" or its affiliates and/or subsidiaries in the United States and/or other countries. **onsemi** owns the rights to a number of patents, trademarks, copyrights, trade secrets, and other intellectual property. A listing of **onsemi**'s product/patent coverage may be accessed at www.onsemi.com/site/pdf/Patent-Marking.pdf. **onsemi** reserves the right to make changes at any time to any products or information herein, without notice. The information herein is provided "as-is" and **onsemi** makes no warranty, representation or guarantee regarding the accuracy of the information, product features, availability, functionality, or suitability of its products for any particular purpose, nor does **onsemi** assume any liability arising out of the application or use of any product or circuit, and specifically disclaims any and all liability, including without limitation special, consequential or incidental damages. Buyer is responsible for its products and applications using **onsemi** products, including compliance with all laws, regulations and safety requirements or standards, regardless of any support or applications information provided by **onsemi**. "Typical" parameters which may be provided in **onsemi** data sheets and/or specifications can and do vary in different applications and actual performance may vary over time. All operating parameters, including "Typicals" must be validated for each customer application by customer's technical experts. **onsemi** does not convey any license under any of its intellectual property rights nor the rights of others. **onsemi** products are not designed, intended, or authorized for use as a critical component in life support systems or any FDA Class 3 medical devices or medical devices with a same or similar classification in a foreign jurisdiction or any devices intended for implantation in the human body. Should Buyer purchase or use **onsemi** products for any such unintended or unauthorized application, Buyer shall indemnify and hold **onsemi** and its officers, employees, subsidiaries, affiliates, and distributors harmless against all claims, costs, damages, and expenses, and reasonable attorney fees arising out of, directly or indirectly, any claim of personal injury or death associated with such unintended or unauthorized use, even if such claim alleges that **onsemi** was negligent regarding the design or manufacture of the part. **onsemi** is an Equal Opportunity/Affirmative Action Employer. This literature is subject to all applicable copyright laws and is not for resale in any manner.

ADDITIONAL INFORMATION

TECHNICAL PUBLICATIONS:

Technical Library: www.onsemi.com/design/resources/technical-documentation
onsemi Website: www.onsemi.com

ONLINE SUPPORT: www.onsemi.com/support

For additional information, please contact your local Sales Representative at www.onsemi.com/support/sales